

Operator Manual

For printer model:

D508 / D512



PN: 9001177B

SATO America, Inc.

**10350A Nations Ford Road
Charlotte, NC 28273**

Main Phone: (704) 644.1650

Technical Support: (704) 644.1660

Technical Support Fax: (704) 644.1661

E-Mail: satosales@satoamerica.com

techsupport@satoamerica.com

www.satoamerica.com

Copyright 2008 SATO America, Inc. All rights reserved

WARNING

THE EQUIPMENT REFERENCED IN THIS DOCUMENT COMPLIES WITH THE REQUIREMENTS IN PART 15 OF FCC RULES FOR A CLASS B COMPUTING DEVICE. OPERATION OF THIS EQUIPMENT IN A RESIDENTIAL AREA MAY CAUSE UNACCEPTABLE INTERFERENCE TO RADIO AND TV RECEPTION.

TABLE OF CONTENTS

OVERVIEW

1.1 Introduction	1-2
------------------------	-----

INSTALLATION

Safety Precautions.....	2-2
2.1 Unpacking.....	2-4
2.1.1 Printer Part Names.....	2-5
2.1.1 SETTING UP THE PRINTER	2-6
2.2 Loading Media.....	2-7
2.3 Label Sensing.....	2-9

CONFIGURATION AND OPERATION

3.1 Operating PANEL.....	3-1
3.2 THE REAR PANEL	3-2
3.3 THE CONFIGURATION PANEL	3-3
Switch 4: Unused	3-4
Switch 5: Head Check.....	3-5
Switch 6: VR1 Potentiometer Adjustment mode.....	3-5
3.4 Error Codes	3-7
3.5 Offsets.....	3-8
3.6 Potentiometer Adjustments	3-9
3.6 Potentiometer Adjustments (Cont'd)	3-10
3.7 DATA Dump Diagnostic Label	3-11
3.8 Printing Test Labels.....	3-12
3.9 Printing Factory/Service Test Prints	3-13

CLEANING AND MAINTENANCE

4.1 Introduction	4-1
4.2 Adjusting the Print Quality.....	4-1
4.3 CLEANING THE PRINT HEAD, PLATEN AND ROLLERS.....	4-2
4.4 Releasing/Replacing the Print Head	4-4
4.4 Cleaning the Sensor	4-5

INTERFACE SPECIFICATIONS

5.1 Interface types.....	5-1
5.2 The Receive Buffer	5-2
5.3 IEEE1284 Parallel Interface	5-4
5.4 RS-232C Interface	5-5
5.4.1 RS-232C Interface Signals	5-6
5.5 Universal Serial Bus Interface	5-7

5.6 Local Area Network Interface5-7
5.7 WIRELESS LAN INTERFACE (802.11 b/g).....5-8

TROUBLESHOOTING

6.1 Initial Checklist6-1
6.2 Checking the IEEE1284 Parallel Interface6-1
6.3 Error Signals.....6-5
6.3 Checking the 802.11G Wireless Interface6-6

SATO CONTACTS

SATO Group of companies7-2

1

OVERVIEW

Thank you for your investment in this SATO printer product.

This Operator's Manual contains basic information about the installation, setup, configuration, operation and maintenance of the printer.

A total of seven topics are covered herein, and they are organized as follows:

- Section 1: Introduction**
- Section 2: Installation**
- Section 3: Configuration and Operation**
- Section 4: Cleaning and Maintenance**
- Section 5: Interface Specifications**
- Section 6: Troubleshooting**

It is recommended that you become familiar with each section before installing and maintaining the printer. Refer to the **Table Of Contents** at the front of this manual to search for the relevant information needed. All page numbers in this manual consist of a section number followed by the page number within the stated section.

Note:

All information herein was correct and current at the time of publication. The contents of this document are subject to revision and change without prior notification to users. To obtain the most current version of this document, refer to the SATO America website at www.satoamerica.com.

1.1 INTRODUCTION

The SATO D508/D512 Printer Operator Manual provides information for installing and maintaining D508/D512 Direct Thermal printers. It is recommended that you become familiar with each section in this manual before installing and maintaining the printer.

The major difference in the D508 and the D512 printers is the resolution of the print head. The D508 with its 203 dpi head provides an economical labeling solution for most applications. The D512's higher 305 dpi resolution provides greater detail for graphics and small point size text.

The D5 Series printers use a subset of the standard SATO Command Language. The D508 and D512 share the same command set, the only differences are the allowable values representing the print positions on the label. These values are specified in "dots" and will vary depending upon the resolution of the printer and the amount of memory available for imaging the label. The allowable range for each printer is specified in a table for those command codes. In addition, users can choose an interface—such as parallel (IEEE1284), serial (RS-232C), Ethernet (10/100-BaseT), USB 1.1 and Wireless LAN IEEE 802.11b.

The following general information is presented in this section:

- **General Printer Specifications**

1.1 GENERAL PRINTER SPECIFICATIONS

Attribute	
PRINT	
Print Method	Direct Thermal
CPU	32-bit RISC processor
Printer Command Language	SATO (SBPL) and PCL5e Subset
Font / Symbologies	SATO Printer Command Language (for 203 dpi and 305 dpi):
Font	U, S, M, WB, XS, XU, XM, XB, XL, OUTLINE, OCR-A, OCR-B, WL, CG Times, CG Triumvirate
Linear Barcode	UPC-A, UPC-E, EAN-8, EAN13, Code 39, Code 93, Code 128, Codabar, MSI, Bookland, Industrial 2/5, Interleaved 2/5, Matrix 2/5, Postnet, UCC/EAN 128, RSS Composite Code
2-D Barcode	PDF417, Micro PDF417, Truncated PDF417, Maxicode, Data matrix, QR Code
	PCL5e Subset (Optional for 305 dpi only):
Font	CG Triumvirate Bold Condensed Bold, Univers Medium, Univers Bold, Courier Regular, OCR-A, OCR-B, Roman Pillar Regular, Roman Pillar Bold, Roman Pillar Italic, Roman Pillar Bold Italic (supports Universal Font Scaling Technology Ver. 4.1)
Linear Barcode	UPC-A, UPC-E, EAN-8, EAN13, Code39, Code 93, Code 128, MSI, Bookland, Industrial 2/5, Interleaved 2/5, Matrix 2/5, Postnet, UCC/EAN 128
2-D Barcode	PDF417, Maxicode
Font Memory	4 MB
Print Head Resolution	8 dots per mm for 203 dpi 12 dots per mm for 305 dpi
Print Speed	For D508: 6 ips (150 mm/second) For D512: 4 ips (100 mm/second)
Max. Print Area	4.1" (104 mm) W by 15.7" (400 mm) L

1.1 GENERAL SPECIFICATIONS (CONT'D)

Attribute	
MEDIA	
Media Type	Roll and fanfold
Label Thickness (Label + backing paper)	0.0026" (0.6 mm*) - 0.007" (* 0.19 mm) *Check with your dealer regarding conditions for using thin 0.002" (06 mm) labels
Label Form	Roll Label: Maximum outer diameter of 4.33" (110 mm) face out Core Inner Diameter of 1.5" (40 mm) Outer Diameter: 4.33" (110 mm) Fan-fold label: Max. foldable height: 3.94" (100 mm) loaded externally) Wind Orientation: Face-out
Label Size (adhesive labels)	Width for all types: 1.1" (28 mm) - 4.65" (118 mm) For continuous feed: Length: 0.71" (18 mm) - 15.75" (400 mm) For Cutter usage (optional): Length: 1.1" (23 mm) - 15.75" (400 mm) For Tear Off mode: Length: 0.71" (18 mm) - 15.75" (400 mm)
SENSING	
See-Through	For die-cut label with gap: Fixed, 0.25" (6.3 mm) from left label edge
Continuous Form	Sensor not used
Eye Mark	Reflective sensor (for use with Pre-printed eye marks)
*All specifications subject to change without notice.	

1.1 GENERAL SPECIFICATIONS (CONT'D)

Attributes	
CONTROLS AND SIGNALS	
On-Line LED	Green
Power LED	Green
Error LED	Red
LED Display Panel	7-Segment Single Character
On/Off-Line Button	Front Panel
Label Feed Button	Front Panel
Power On/Off Button	Front Panel
Self Diagnostics	Head check Paper end Cover open Test print
POTENTIOMETER ADJUSTMENTS	
Adjustment Potentiometers	VR1: Offset level (DIPSW6 = OFF) VR1: Print darkness (DIPSW6 = ON) VR2: Eye Mark VR3: Gap sensor (to adjust the threshold) VR4: Label pitch offset
DIP switches	DIP-SW -1,2,3 : Operation mode(Print mode/Download mode) DIP-SW -4 : Reserved (constantly OFF) DIP-SW -5 : Head check (ON-Enabled / OFF-Disabled) DIP-SW -6 : VR1 function switch (ON-Print darkness level / OFF-Offset) DIP-SW -7 : DATA dump (ON-HEX dump print / OFF-Normal print) DIP-SW -8 : Reserved (constantly OFF)
INTERFACE CONNECTIONS	
Parallel (Option)	IEEE1284
Serial (Option)	RS232C (up to 57.6K bps) Hardware Flow Control (Ready/Busy) Software Flow Control (X-On/X-Off) Bi-directional Status
USB (Option)	USB Specification Version 1.1
LAN (Option)	10/100 Base-T
RFID (Option)	TBA
Wireless LAN (Option)	802.11 b/g (internal)
*All specifications subject to change without notice.	

1.1 GENERAL SPECIFICATIONS (CONT'D)

Barcodes	
SYMBOLOGIES	
Supported 1D formats (excluding customized barcode addressing in firmware)	UPC-A/E EAN-8/EAN-13 CODABAR CODE39 CODE93 CODE128 UCC/EAN128 Interleaved 2 of 5 Industrial 2 of 5 Matrix 2of5 RSS Composite MSI POSTNET Bookland
Supported 2D formats	PDF 417 Micro PDF 417 Truncated PDF 417 Maxicode Data Matrix QR Code
Ratios	1:2, 1:3, 2:5 User definable bar widths (depending on software)
Bar Height	4 to 600 dots (depending on software)
Rotation	0°, 90°, 180° and 270° (depending on software)
<i>*All specifications subject to change without notice.</i>	

Physical Attributes	
DIMENSIONS	
Width	7.8 in. (198 mm)
Depth	9.1 in. (230 mm)
Height	6.6 in. (167 mm)
Weight	5.5 lbs (2.5 Kg) excluding AC adaptor
POWER REQUIREMENTS	
Voltage	USA: AC 115 V (+/- 10 %) 50/60 Hz (+/-1%)
Power Consumption	67W nominal
ENVIRONMENTAL	
Operating	32° to 95°F (0° to 35°C), 30 to 80% RH, non-condensing
Storage	23° to 140°F (-5° to 60°C), 30-90% RH, non-condensing
REGULATORY APPROVALS	
Safety	USA : UL(UL60950-1) CANADA : C-UL(CSA C22.2 No.60950-1-3)
EMC/EMS	USA : FCC15B (ClassB)

Optional Accessories	
220V Power Supply	Auto-switching
Internal Cutter	User or factory installed Internal option allowing labels to be cut at specified intervals.
IEEE1284 Interface	Parallel interface. Factory or User installable
Serial Interface	High Speed RS232 Interface option, 9600 bps to 57.6 Kbps. Factory or User installable.
LAN Interface	TCP/IP Protocol Interface option. Factory or User installable.
USB Interface	Universal Serial Bus Interface option. Factory or User installable.
RFID	To be announced
Wireless LAN Interface	802.11 b/g
<i>*All specifications subject to change without notice.</i>	

2

INSTALLATION

This section assists you in unpacking the printer from the shipping container. You will also be guided through a familiarization tour of the main parts and controls. The following information is provided herein:

- **Safety Precautions**
- **Unpacking and Parts Identification**
- **Loading Media**
- **Adjusting the Sensor**

SAFETY PRECAUTIONS

Please read the following information carefully before installing and using the printer

<p>THE CAUTION SYMBOL </p> <p>Whenever the triangular Caution logo appears in this manual, pay special attention to the warning(s) cited below it. Failure to abide by the warnings may result in injury or damage to property.</p>	
<p>PRINTER PLACEMENT TIPS</p>	
<ul style="list-style-type: none"> • Place the printer on a solid, stable, horizontal surface that is not subject to strong vibrations from adjacent mechanical devices. • Avoid shaky or slanting tables, or platforms that are liable to collapse under a heavy weight. If the printer is dropped or damaged, immediately turn off the power, pull out the power plug and contact a service center. In this case, continued use of the printer may cause a fire or electric shocks. • Avoid installing the printer in direct sunlight, or in dusty, very hot or slippery areas. Also avoid placement in damp, unventilated or humid areas. If condensation forms, immediately turn off the power, and do not use the printer until the condensation disappears. Otherwise the moisture may cause electric shocks. • Avoid placing the printer near large high-current equipment, as such equipment can cause spikes or undervoltages in the power supply. 	<ul style="list-style-type: none"> • Do not leave containers of water or chemicals around the printer. If any liquid is spilled onto the printer, immediately turn off the power, pull out the power cable from the AC outlet, and contact a sales outlet, dealer, or service center. In this case, continued use of the printer may cause fires or electric shocks. • Do not move the printer with any paper loaded. The stack of paper may fall off, causing trips and accidents. • When laying the printer down, be careful not to catch your foot or fingers under it. • When moving the printer, be sure to pull out the power cable from the AC outlet, and check that any other external interface cables have been disconnected. Otherwise, the connected cables may be damaged, or may cause trips and falls, in addition to or a fire or electric shocks.
<p>ELECTRICAL PRECAUTIONS</p>	
<ul style="list-style-type: none"> • Do not damage, break, or process the power cable. Hanging heavy objects on it, heating or pulling it may damage the power cable and cause fires or electric shocks. • When the power cable is damaged (cable conductors are exposed or cut, etc.), contact a sales outlet, dealer, or service center. In this case, continued use of the printer may cause fires or electric shocks. • Do not process, forcibly bend, twist, or pull the power cable. Continued use of such a cable may cause fires or electric shocks. • If the printer emits any smoke or peculiar odors at any time, turn it OFF and prevent further usage until you have contacted a qualified service personnel. • Do not use any other voltage except the specified power voltage for the printer that matches your domestic power supply. Otherwise, it may cause fires or electric shocks. 	<ul style="list-style-type: none"> • Do not operate the power switch or handle the power cable with a wet hand. • Do not insert or drop anything metallic or flammable into the openings of the printer (the cable outlet or mounting hole of the memory cartridge). Otherwise, immediately turn off the power, pull out the power cable, and contact a sales outlet, dealer, or service center. In this case, continued use of the printer may cause fires or electric shocks. • To reduce electrical risks, be sure to connect the printer to ground before use. Also, try not to share the printer's AC outlet with other electrical equipment, especially those that draw high amounts of current or cause electrical interference.

GENERAL PRECAUTIONS

- | | |
|---|---|
| <ul style="list-style-type: none"> • When using head cleaning liquid, note that it is flammable. Never heat it or throw it into a fire. Keep it out of children's reach to avoid accidental consumption. Should this occur, consult a doctor immediately. • When opening/closing the cover, beware of getting your fingers caught. Also, hold the opening/closing cover well so that it will not slip and fall onto the hand. • After printing, the print head remains hot. When replacing paper or cleaning the printer immediately after printing, be careful not to burn yourself. • Touching even the edge of the printer head may cause injuries. When replacing paper or cleaning the printer, be careful not to hurt yourself. • If the printer will not be used for extended periods of time, disconnect the power cable for safety. • When releasing and locking down the printer head, be careful not to catch any other foreign matter in it except label paper. | <ul style="list-style-type: none"> • Do not disassemble or perform modifications to the printer, as this renders the product unsafe. For maintenance, troubleshooting and repairs, consult a sales outlet, dealer, or service center for help, instead of attempting to perform this yourself. Renewable annual service contracts are available. • When maintaining or cleaning the printer, always disconnect the power cable for safety. • Do not insert your hand or other objects into the cutter. • When loading roll paper, be careful not to catch your fingers between the paper and the feeder. • Be careful not to hurt yourself when detaching the back cover of the fanfold through the hole and attaching it. • The simplified cutter (if applicable to the printer) is structured as a blade. Be careful not to cut yourself. |
|---|---|

This is a piece of Class B information technology equipment based on the standards of the Voluntary Control Council for Interference by Information Technology Equipment (VCCI). Although this equipment is for use in home environment, if it is used close to a radio or television set, it may cause poor reception. Handle it properly in accordance with the content from the instruction manual.

SECTION 2: INSTALLATION

2.1 UNPACKING

When unpacking the printer, take note of the following:

1 The box should stay right-side up. Lift the printer out of the box carefully.	4 If the printer has been stored in the cold, allow it to reach room temperature before turning it on.
2 Remove the plastic covering from the printer.	5 Set the printer on a solid, flat surface. Inspect the shipping container and printer for any sign of damage that may have occurred during shipping.
3 Remove the accessory items from their protective containers.	

Note:

The following parts shown here are representative only. Due to regional requirements and our policy of continual improvement, your printer may not be packed with the exact parts as shown here, but the unpacking steps are similar.



Printer



AC adaptor and cable



User documentation and software package (where applicable)

2.1.1 PRINTER PART NAMES

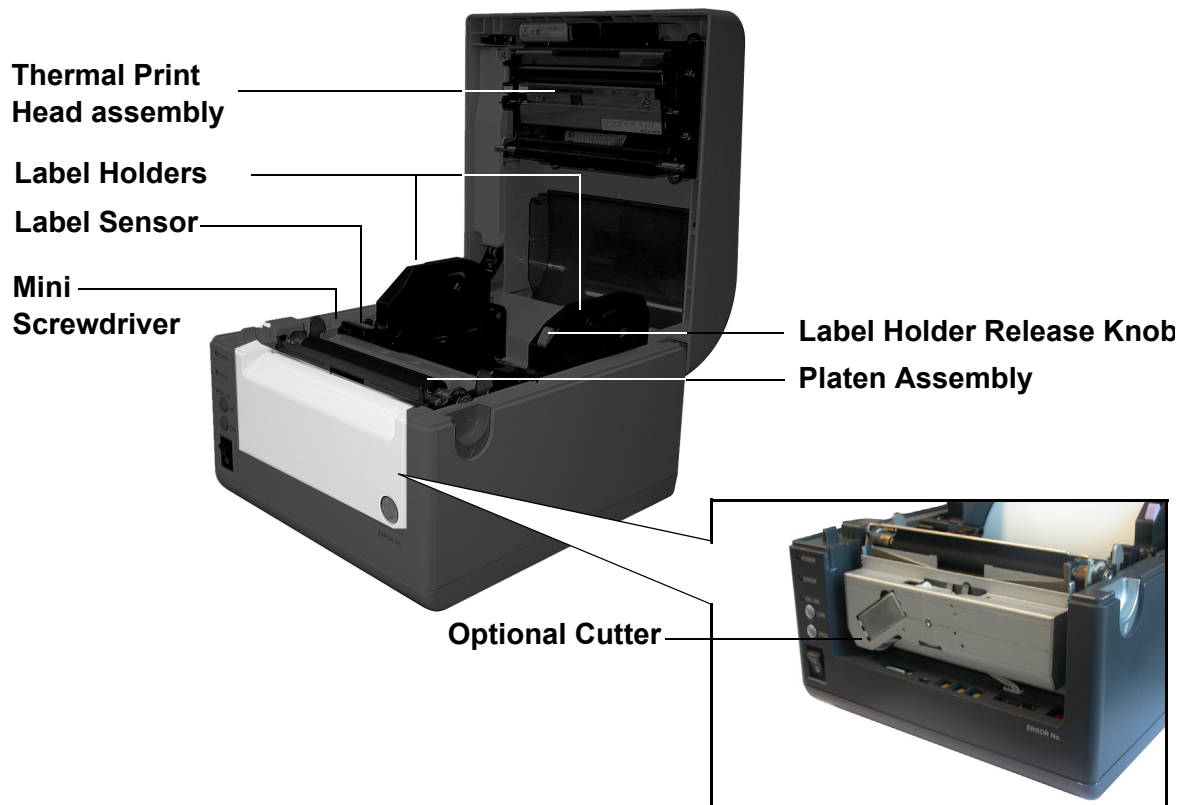
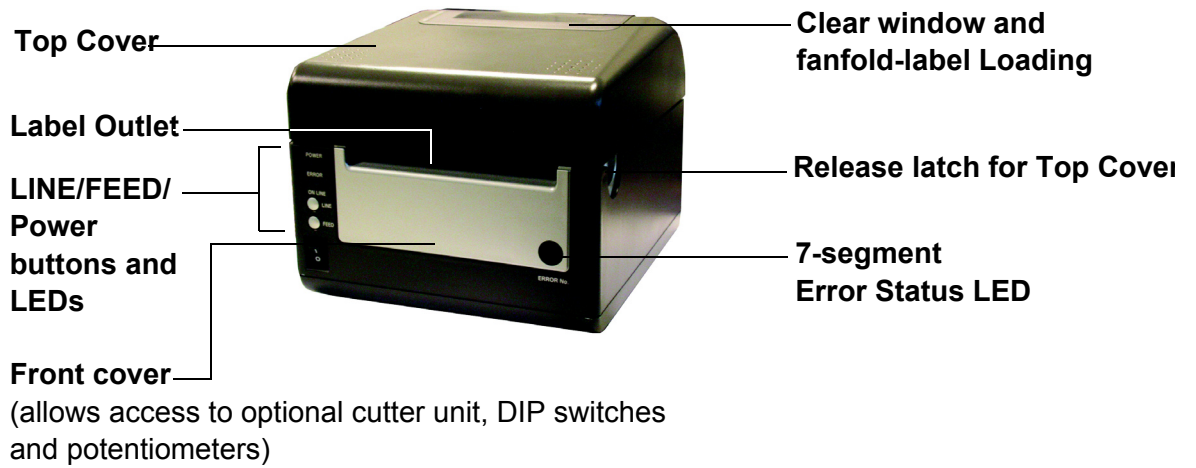

SECTION 2: INSTALLATION

2.1.1 SETTING UP THE PRINTER

Consider the following when setting up the printer:

Locate a solid flat surface with adequate room to set the printer. Make sure the AC adaptor can be located so that the AC power cable can be attached to the printer and an AC power outlet. The location should be near the host or computer terminal. The maximum distance recommended is:

- 10 feet for a Parallel interface cable. Make sure it meets IEEE1284 specifications
- 18 feet for the optional Serial RS232 Interface
- 10 feet for the optional USB interface without hub
- the optional 10baseT Ethernet Interface depends upon the LAN cabling
- Up to 100m for the Wireless LAN, depending on structural conditions

Follow these steps to set up your printer:

1. Make sure the power switch on the Operator Panel is in the OFF (0) position and place the AC adaptor in a safe and secure location.
2. Connect the Input Power connector to the printer. This connector is buttoned and must be turned approximately 3/4 turn clockwise to secure it to the printer.
3. Connect the AC Power Cable to an AC Outlet supply of an appropriate voltage.
4. Connect the interface cable to the host system. If you are using the Parallel Port connection, a parallel IEEE1284 interface cable must be used to realize the high data transfer rate of the printer's parallel port. If another interface is installed, the appropriate cable should be used.
5. Load the label media following the instructions in this section.

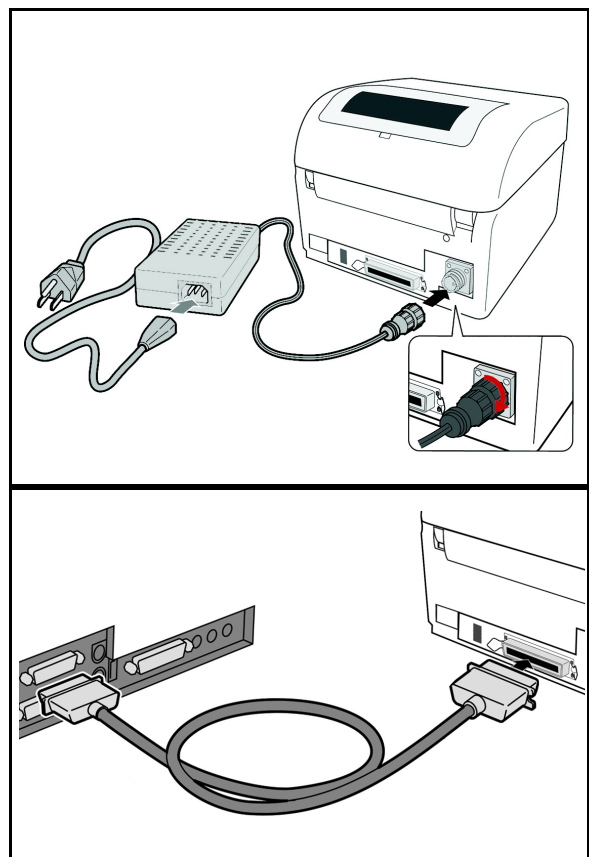

6. Configure the printer for label width and operating mode using the instructions in this section.
7. Press the printer power button to the ON (I) position.
8. Print a test label to verify the printer is set up and operating correctly.

2.2 LOADING MEDIA

The SATO D508 / D512 printer can print to direct thermal die-cut labels, tags or continuous media. The media supply can be either in Roll or Fanfold format.

Roll Media

Roll media should be between 0.98" (25 mm) and 4.3" (110 mm) in width and wound face-out on a core with a minimum internal diameter of 1.6" (40 mm).

1. Make sure the printer is turned OFF.
2. Open the Top Cover by pressing on cover release points located on the right-hand side of the printer. This releases the Top Cover and allows it to swing upward on the rear mounted hinge points.
3. With the Top Cover in the upright position, press the Paper Guide Release while adjusting the Paper Guides until they allow a media roll to fit between them. A millimeter scale is molded into the case to provide a guide when making the adjustment. The Paper Guides are center justified and interact with each other so that each moves an equal distance.
4. Make sure the Roll Holders are in the released position. If they are not, lift up on each one and they will snap to the open position.

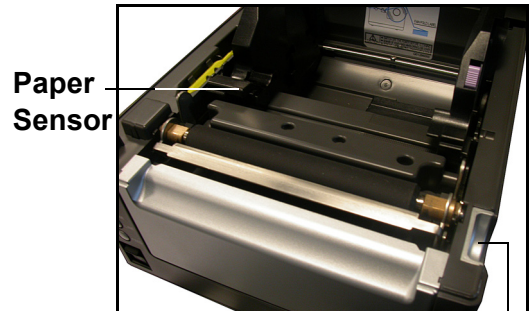

Cover/Print Head Release Latch

Roll Holders



Millimeter scale

Paper Guide Release

5. Unwind approximately 12" of label material from the roll. The labels should be wound face-out (printing side to the outside of the roll). Drop the roll in-between the Paper Guides so that the labels come off the top of the roll. The Paper Guides will automatically position the Roll Holders to suspend the roll.

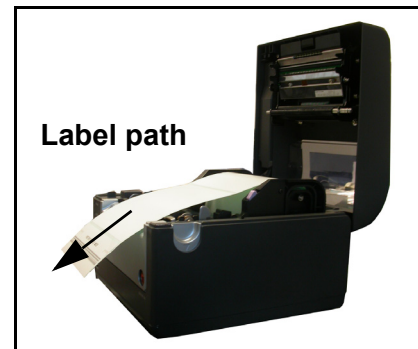

Label path

SECTION 2: INSTALLATION

6. Route the label material through the Paper Sensor Assembly and over the Platen. Note that the Sensor is part of the left Label Roll Guide so that the Paper Sensor is always positioned in the same location relative to the left edge of the label.
7. Close the Top Cover.
8. Press the LINE button so that the printer is in the OFF LINE mode and then press the FEED button. The label should advance to the next index (label gap) position.

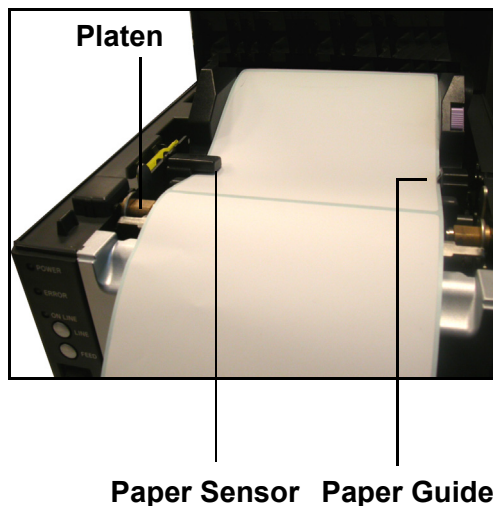

Fanfold media

1. Place the fanfold media behind the printer with the printing surface up.
2. Open the Top Cover by pressing on the cover release latch located on the right-hand side of the printer. This releases the cover and allows it to swing upward on the rear mounted hinge points.
3. Carefully pull up the Fanfold-label Loading Slot from the back of the Top Cover.
4. With the Top Cover in the upright position, press the Paper Guide Release while adjusting the Paper Guides until they allow a media to fit between them. A millimeter scale is molded into the case to provide a guide when making the adjustment. The Paper Guides are center-justified and interact with each other so that each moves an equal distance apart from each other.
5. Route the label material through the Sensor Assembly and over the Platen.

Fanfold-label Loading slot



Pull up the loading slot



Pull open the Top Cover



Load the fanfold paper

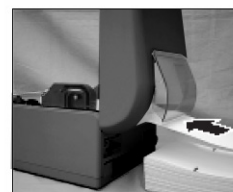

6. Close the Top Cover.
7. After loading the label media, it is recommended that you run a Test Print to make sure the labels are correctly loaded and printed.

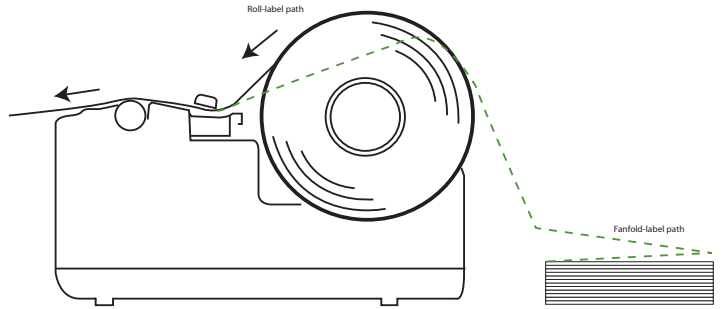

Overview of the fanfold-paper loading path

2.3 LABEL SENSING

The SATO D508 / D512 printer uses label Gap (see-through) sensing. The Sensor Assembly is located on the left edge of the media and is automatically positioned by the Paper Guides.

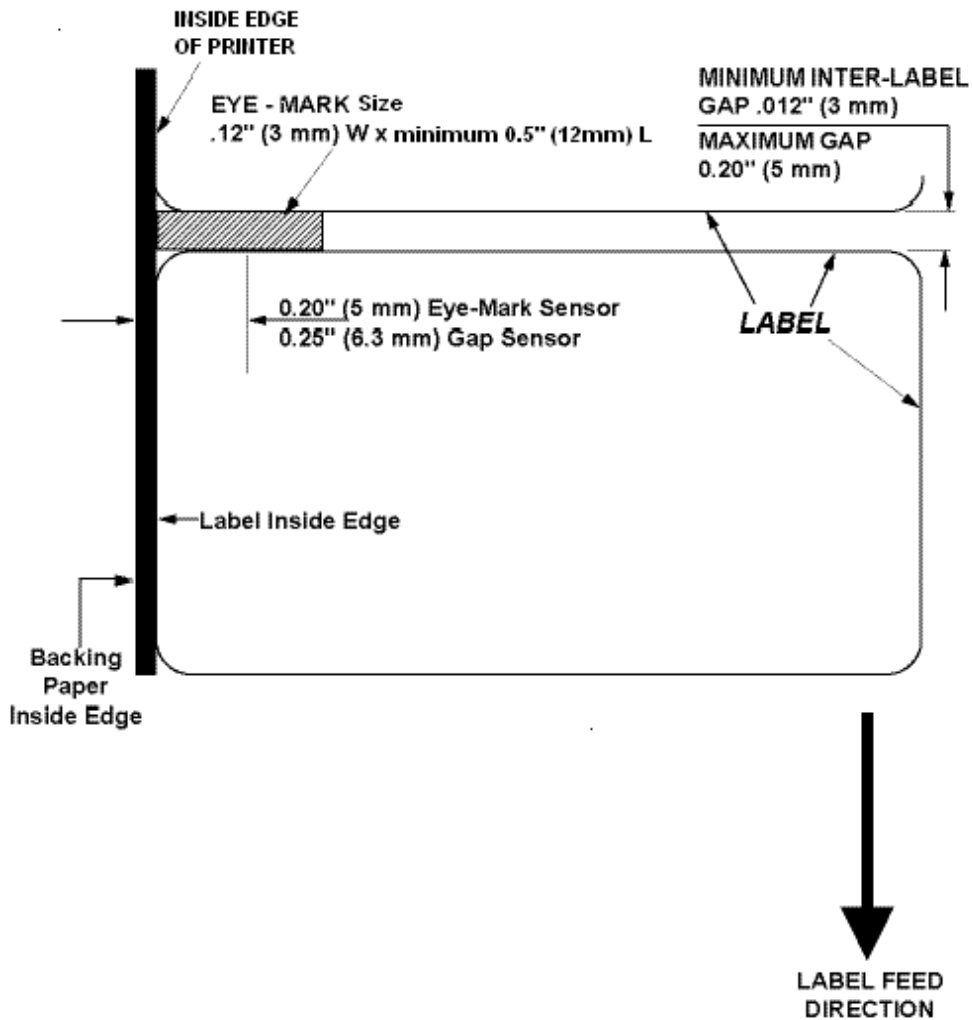

SECTION 2: INSTALLATION

This page is left blank intentionally

3

CONFIGURATION AND OPERATION

Before using the printer, it is best to read this manual thoroughly first. Otherwise, you may disturb default settings around which the instructional procedures in this manual are based upon.

3.1 OPERATING PANEL

The Operator Panel consists of three LED indicators and three switches.

POWER

The green LED lights up when the printer is ON.

ERROR

The red LED lights up when there is a system fault such as an unlatched print head.

ON LINE

The green LED lights up when the printer is ON LINE and ready to receive data. The ON LINE button takes the printer ON LINE or OFF LINE.

LINE Button

If the ON LINE LED is lit, pressing it will take the printer OFF LINE. Pressing the button again then takes the printer back ON LINE. When ON LINE, the printer is ready to receive data from the host. When OFF LINE, the printer will not print or accept data from the host. While the printer is printing, press this button to suspend the printing. To resume printing, press this button again.

FEED BUTTON

Press this button to eject one label in OFF LINE mode. Hold this button down while power is applied, to print a printer status label.

POWER SWITCH

A two position switch for turning the printer ON (I) or OFF (O).

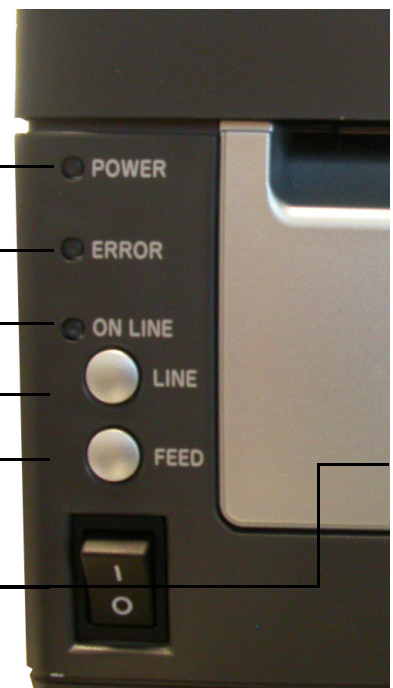

3.2 THE REAR PANEL

All of the printer cable connectors are located on the Rear Panel, as follows.

Fanfold-label Loading Slot

Remove this panel to route fanfold paper into the printer



**IEEE1284
Parallel
Interface
Connector**

**Power
Connector**
for DC power
input from the
supplied AC
Adapter

3.3 THE CONFIGURATION PANEL

The Configuration Panel is accessible when you lift up the top cover.

The panel consists of an eight-position DIP switch, four adjustment potentiometers and a seven-segment LED Error Status display. Receptacles for connecting the optional Cutter (factory installed) are also located on this panel.

Change and fine-tune your printer settings as required by using the mini-screw driver to turn the potentiometers clockwise/anti-clockwise until you have the optimal adjustment position.

Do not touch VR2 and VR3. They are reserved for professional adjustments and for a trained service person only.

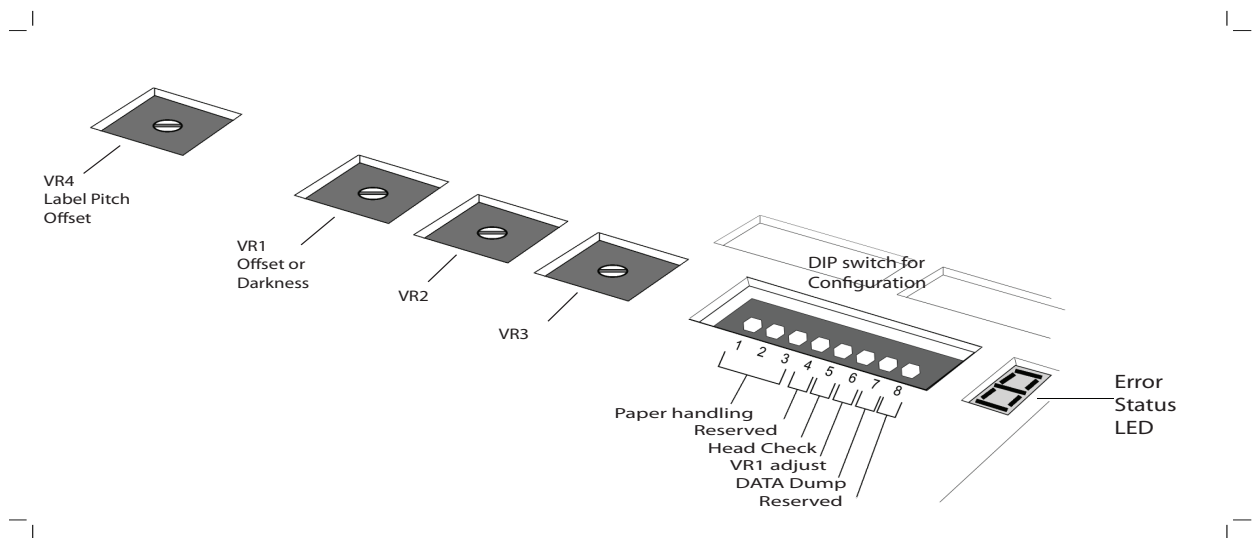

DIP SWITCH SETTINGS

This is an eight-position switch used for setting the operating conditions of the printer. Switches 1 to 3 act as control for both paper handling and the loading of programs or fonts into the printer.

Switches 1–3: Paper Handling settings

These three switches select the method used for controlling paper handling:

Continuous mode - (default mode) Does not use the sensor for paper indexing. The paper movement will stop after all the label data has been printed.

Tear Off mode - Paper is fed out to the cut/tear off position after printing is complete. Before the next label is printed, the paper is pulled back in to the first print line position.

Cutter mode - Enables the Cutter option if installed.

DSW1	DSW2	DSW3	Mode
Off	Off	Off	Continuous
On	Off	Off	Tear Off
Off	On	Off	Cutter
On	Off	On	Reserved
Off	On	On	Load Font

Configuration Switch

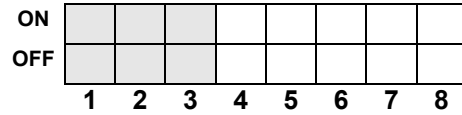

3.3 DIP SWITCH SETTINGS (CONT'D)

Switches 1–3: Font/Graphic loading settings

Enables the loading of fonts and/or graphics into printer memory for faster retrieval.

DSW1	DSW2	DSW3	Mode
Off	On	On	Load Font

Configuration Switch

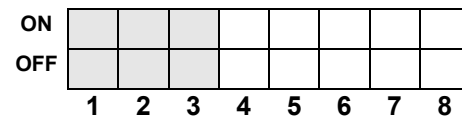

Switch 4: Unused

This switch is reserved for future use.

DSW4	Mode
Off	DT
-	Reserved

Configuration Switch

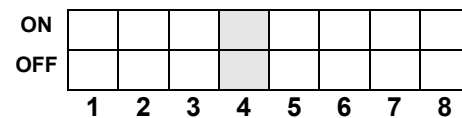

Switch 5: Head Check

Enables or Disables the printer function that checks the print head automatically.

DSW5	Mode
Off	Disabled
On	Enabled

Configuration Switch

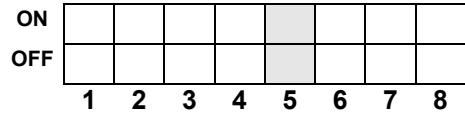

Switch 6: VR1 Potentiometer Adjustment mode

Selects the function adjusted by VR1. When placed in the Off position, VR1 will adjust the media tear-off / cut (backfeed distance) offset value over a range of +/- 3.75 mm. When placed in the On position, VR1 will adjust the print darkness range.

DSW6	Mode
Off	Media Tear-off
On	Print Darkness

Configuration Switch

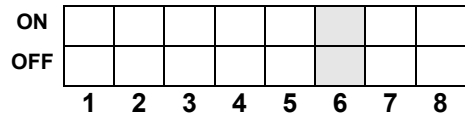

3.3 DIP SWITCH SETTINGS (CONT'D)

Switch 7: DATA Dump

When ON, the printer will print out the hex value for each character received. When OFF, the printer will accept and process the data stream in a normal fashion.

DSW7	Mode
Off	DISABLED
On	ENABLED

Configuration Switch

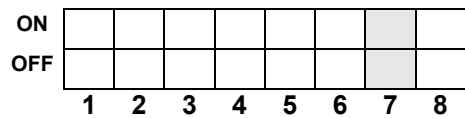

Switch 8: Unused

This switch is reserved for future use.

DSW8	Mode
-	-
-	-

Configuration Switch

ON								
OFF								
	1	2	3	4	5	6	7	8

3.4 ERROR CODES

The ERROR display is a seven-segment LED array that provides information on error conditions detected by the printer. The conditions are:

0		ON	1 Beep	Flash Memory error	Consult your SATO dealer
1				Not Assigned	
2		ON	1 Beep	Machine Error	Consult your SATO dealer
3		ON	1 Beep	EEPROM Error	Replace EEPROM
4		ON	1 Beep	Electrical Head error	Replace Print Head or consult your SATO dealer
5		Blink	3 Beeps	Head Not Latched	Latch Print Head securely and make sure the Top Cover is closed properly
6		Blink	3 Beeps	Out of Paper	1) Replenish paper supply 2) Route paper through sensor correctly
7		Blink	3 Beeps	Sensor error	1) Adjust sensor level
8		Blink	3 Beeps	Cutter error	Connect cutter (optional item) properly or consult your SATO dealer
8.	ON	ON		Program Error	Resend data to the printer
A	ON		1 Beep	Receive Buffer Overflow	1) Restart the printer and retry 2) Modify host SW 3) Select correct communication protocol settings
b	ON		1 Beep	Parity error (Serial I/F only)	Correct the Parity Settings or consult your SATO dealer
c	ON		1 Beep	Framing Error (Serial I/F only)	Check and correct the data bit setting and retry
d	ON		1 Beep	Overrun Error (Serial I/F only)	Check and correct the flow control settings and retry
E	ON		1 Beep	LAN Time Out Error	Check the Interface Card and all associated connections to/from it. Replace if necessary
F			3 Beeps	Font/graphic Data Error (Serial I/F only)	Recheck and correct the data stream and retry

For more information on the cause and troubleshooting of printer errors, see **Section 6. Troubleshooting**.

3.5 OFFSETS

There are **two** offset settings stored in the printer; one for the **Cut mode** and one for the **Tear-Off mode**.

These two offsets can be set independently and will remain in the printer until a new command is received changing the setting or until power is turned off.

The default settings can be determined by printing a User Test Label.

The following should be used as starting points for establishing the three Offset values:

Mode	Length of Offset (mm)	Length of Offset (in)	Print head resolution
CUTTER	17.9	0.70	143/215
TEAR-OFF	29.2	1.15	234/350

3.6 POTENTIOMETER ADJUSTMENTS

PITCH OFFSET

This can be done using the VR4 potentiometer on the Configuration Panel. This potentiometer is set at the factory so that it has a range of ± 3.75 mm. The midpoint setting should have no effect on the label pitch. Turning the potentiometer all the way clockwise should move the print position 3.75 mm upwards towards the leading edge of the label. Turning it all the way counterclockwise should move the print position down 3.75mm away from the leading edge of the label.

1. Place DSW6 on the Configuration Switch in the OFF position.
2. Turn the power OFF.
3. While pressing the FEED button on the Operator Panel, turn the power ON.
4. When you hear one beep from the printer, release the FEED button.
5. Press the LINE button to begin printing large Test Labels (press the FEED button if you are using labels smaller than 4.1" (104 mm) in width).
6. Adjust potentiometer VR4 until the first print position is at the desired location on the label.
7. Press the FEED button to stop printing.

Note:

Adjusting the Label Pitch with VR4 will affect the stop position of the label and the cut/tear-off positions.

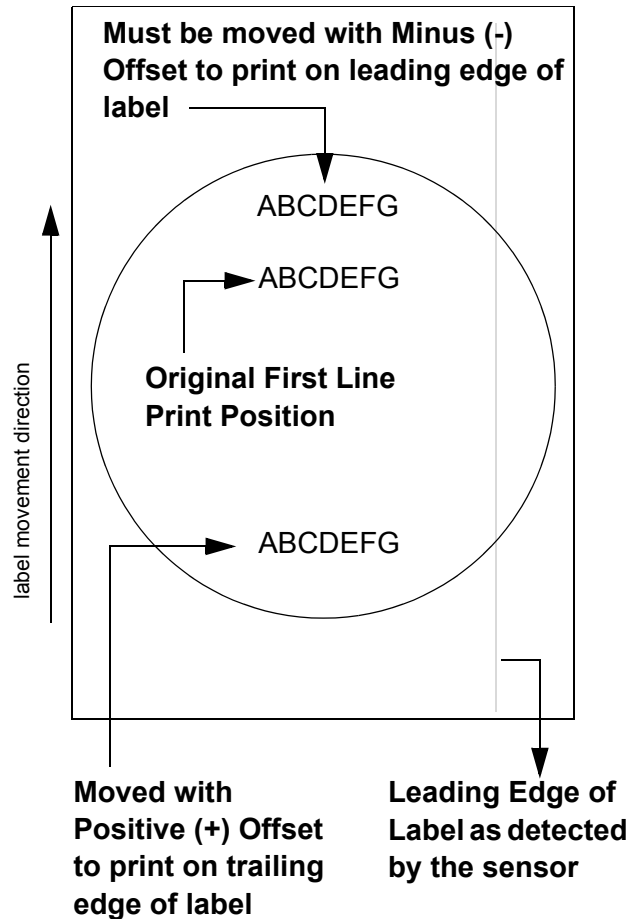

3.6 POTENTIOMETER ADJUSTMENTS (CONT'D)

Print Darkness

A fine adjustment for PRINT DARKNESS can be made using potentiometer VR1 on the Front Operator Panel. It provides a continuous range of adjustment, allowing you to make precise changes. Turning VR1 clockwise will make the print darker, and counterclockwise will make it lighter.

1. Place DSW6 on the Configuration Switch in the ON position.
2. Turn the Power Switch OFF.
3. While pressing the FEED button on the Operator Panel, turn the Power Switch ON.
4. When you hear one beep from the printer, release the FEED button.
5. Press the LINE button to begin printing large Test Labels (press the FEED button if you are using labels smaller than 4.1" (104 mm) in width).
6. Adjust potentiometer VR1 until the desired print darkness is obtained.
7. Press the FEED button to stop the printing.

Adjustment of the Print Darkness using VR1 will affect the darkness in all the <ESC>#E command code ranges; that is, if the print darkness is adjusted with VR1 for lighter print, the darkness will be lighter in all the Print Darkness ranges selected by the command code.

3.7 DATA DUMP DIAGNOSTIC LABEL

The contents of the printer buffer can be examined using the DATA Dump mode. This printout labels each line of the received data in the left hand column, the data in the middle column followed by the same data in ASCII format in the right-hand column.

1. Turn the printer OFF.
2. Place DSW7 on the configuration Switch in the ON position.
3. Turn the printer ON.
4. Transmit data to the printer.
5. The data received is printed on the label.
6. Place DSW7 in the OFF position.
7. Turn the printer OFF and then back ON to place it back in the normal print mode.

```

00000000 1B411B4830303530 1B56303230301B42  %A% H0050% V0200%B
00000010 443130343130302A 434C3430382A1B48 D104100*CL408*%H
00000020 303035301B563030 35301B4254303031 0050% V0050% BT001
00000030 3033303130331B42 5730333130303132 030103% BW0310012
00000040 333435360D0A1B51 311B5A0D0A 3456 %L% Q1%Z %L%

```

Note:

Depending on the version of your printer's onboard software, the appearance of your test printout may be different from that shown here.

3.8 PRINTING TEST LABELS

1. The User Test Label prints the current default settings of the printer.
2. Press the FEED button while turning the power ON.
3. When the printer beeps, release the FEED button.
4. To print a large (4" wide) test label, press the LINE button. To print a small (2" wide) test label, press the FEED button.
5. The printer will continuously print the USER TEST LABEL until the FEED button is pressed. If the FEED button is pressed another time, printing will resume.
6. To remove the printer from the Test Label mode, power the printer OFF.

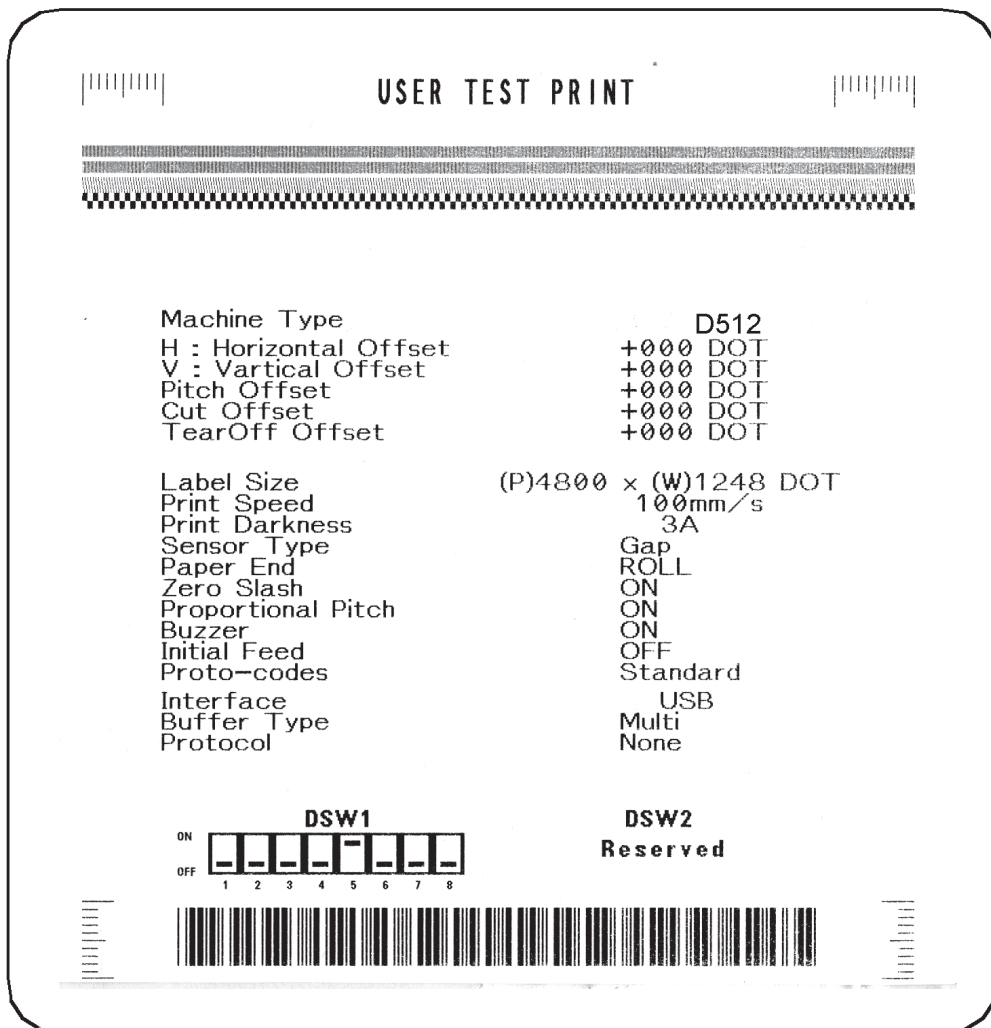

Note: Depending on the version of your printer's onboard software, the appearance of your test printout may be different from that shown here.

3.9 PRINTING FACTORY/SERVICE TEST PRINTS

The Factory/Service Test Label prints the internal operating parameters of the printer.

1. Release the print head. (see "Releasing/Replacing the Print Head" on page 4-3).
2. Press the LINE and FEED buttons while turning the printer ON.
3. When the printer beeps, release the LINE and FEED buttons. The printer will then beep 3 times indicating it is in the Factory/Service Print Test mode.
4. Relatch the Print Head.
5. Press the LINE button to print a large (4" wide") Factory/Service Test Label. Press the FEED button to print a small (2" wide) Factory/Service Test Label.
6. The printer will begin printing a series of test labels, the first containing the operational parameters of the printer followed by one containing the internal printer settings. These two label formats will alternate until the FEED button is pressed, suspending the print operation. If the FEED button is pressed again, the printing will resume.

To remove the printer from the Factory/Service Print Test mode, remove power by placing the POWER switch in the OFF position.

4

CLEANING AND MAINTENANCE

4.1 INTRODUCTION

This section provides information on user maintenance for the SATO D508/D512 printers. This section contains the following information.

- Adjusting the Print Quality
- Cleaning the Print Head, Platen and Rollers
- Replacing the Print Head
- Replacing the Fuse

4.2 ADJUSTING THE PRINT QUALITY

The SATO D508 / D512 printer is equipped with two different methods of adjusting the quality of the print—**print darkness** and **print speed**.

When adjusting the printer for optimum print quality, a barcode verifier system is highly recommended for evaluating the printouts. The human eye is a poor judge of the relative widths of the bars in a symbol, a characteristic that is extremely important for good bar code quality.

Print Darkness

This adjustment allows the user to control (within a specified range) the amount of power that is used to activate the print head heating elements. It is important to find a proper print darkness level based on your particular label. The printed images should not be too light nor should the edges of text or graphics be smudged. Instead, the edges of each image should be crisp and well defined.

Once the range has been selected, the PRINT Potentiometer (VR1) on the front panel can be used to make finer adjustments. It provides a continuous range of adjustment, allowing you to make precise changes. Use a small cross-point screwdriver, turning clockwise for darker print and counterclockwise for lighter print. DSW6 has to be ON in order for to adjust the print darkness via the VR1 potentiometer. See page 3-3 for instructions on performing potentiometer adjustments.

Note:

Adjustment of the Print Darkness using VR1 will affect the darkness in all the <ESC>#E command code ranges. That is, if the print darkness is adjusted with VR1 for lighter print, the darkness will be lighter in all the Print Darkness ranges selected by the command code.

SECTION 4: CLEANING AND MAINTENANCE

Print Speed

The other method of controlling print quality is by controlling the speed at which the label is printed. It is especially critical when printing "ladder" bar codes (bar codes printed with the bars parallel to the print line). When printing a "ladder" bar code, it is important to allow the head to cool sufficiently before stepping to the next position. If it does not have sufficient time to cool, the bar will be "smeared" on the trailing edge.

This adjustment is made only on an individual label basis using the <ESC> CS command. For more details on this command, see the Programming Reference.

4.3 CLEANING THE PRINT HEAD, PLATEN AND ROLLERS

Cleaning the Print Head

1. Before starting, get ready an approved cleaning kit from your SATO dealer or the kit supplied with the printer. Make sure the printer is OFF, and remove the power cable.
2. Lift up the Top Cover and locate the Print Head Assembly which is mounted under the cover.
3. Apply Thermal Print Head Cleaner to a cotton swab.
4. The Print Head faces downward along the front edge of the assembly. Pass the end of the dampened swab along the entire width of the Print Head.
5. Check for any black coloring or adhesive on the swab after cleaning.
6. Repeat if necessary until the swab is clean after it is passed over the head.
7. The head should be cleaned at least every time the label roll is changed, and more often in harsh environments.



Cleaning Stubborn Debris on the Print Head

1. If certain stains on the print head cannot be removed easily with cotton swabs dabbed in cleaning solution, obtain cleaning sheets designed for cleaning print heads (for such supplies, contact your SATO dealer)
2. Load the cleaning sheet with the rough side facing the print head. Follow any other instructions or precautions printed on any leaflet that may accompany the cleaning sheet.
3. With the printer turned OFF, and the Top Cover closed, slowly pull the cleaning sheet outwards. Repeat the process until the print head is clean.



4.3 CLEANING THE PRINT HEAD, PLATEN AND ROLLERS (CONT'D)

Cleaning the Platen and Paper Roller

1. Before starting, get ready an approved cleaning kit from your SATO dealer or the kit supplied with the printer. Make sure the printer is OFF, and remove the power cable.
2. Lift up the Top Cover.
3. The platen roller is the black rubber roller near the front panel. The print rollers are located at the print head assembly, near the fanfold-label loading window.
4. Wet some cotton swabs with cleaning solution. While rotating the platen roller with your fingers, clean the entire length of the roller using one or more cotton swabs. The roller should be cleaned of any label or adhesive residue.
5. Repeat the whole cleaning process if necessary. The platen and rollers should be cleaned whenever foreign matter such as dust or adhesive is present.

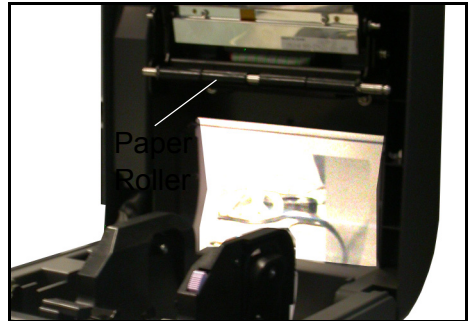

SECTION 4: CLEANING AND MAINTENANCE

4.4 RELEASING/REPLACING THE PRINT HEAD

The print head on the printer is a user-replaceable item. If it becomes damaged for any reason, it can be easily removed and replaced. Contact your local SATO representative for information on obtaining a new print head. You will also need a No. 2 Phillips screwdriver (a magnetic tip is helpful) for the replacement procedure.

1. Make sure the printer is OFF, and remove the power cable.
2. Lift up the Top Cover.
3. Locate the small center tab above the print head. Press and hold down this tab. At the same time, pull the whole print head below it, downwards. If necessary, use the two hooks at the sides of the print head for leverage.
4. After pulling the print head downwards, press its bottom portion so that it tilts inwards on the two aluminum pivots at the sides of the assembly.
5. Now lift the print head upwards and outwards, so that it is no longer restrained by the metal pivots. The cable connector at the rear of the print head is now exposed.
6. Disconnect the connecting cable from the print head connectors and set the print head aside.
7. Carefully attach a replacement print head to the cable connector. The connectors are keyed so that they can only be inserted in the correct orientation.

Note:

While handling the print head, be careful not to scratch the printing surface of the print head. Scratching the surface will cause permanent and irreparable damage that is not covered by the warranty!

8. Reinsert the print head into the printer, making sure that the metal slots at the sides of the print head fit back over the aluminum pivots on the printer.
9. Press and hold down the center tab which was previously used to release the print head. Push the print head upwards so that it snaps into place.
10. Release the center tab and close the Top Cover. Proceed to perform a test print to ensure that the print head is connected properly.

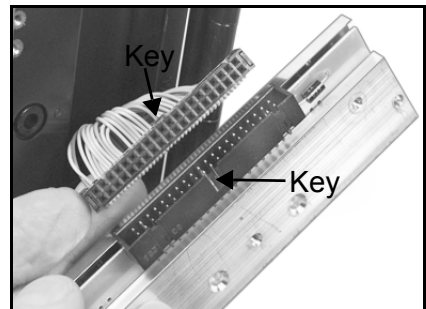
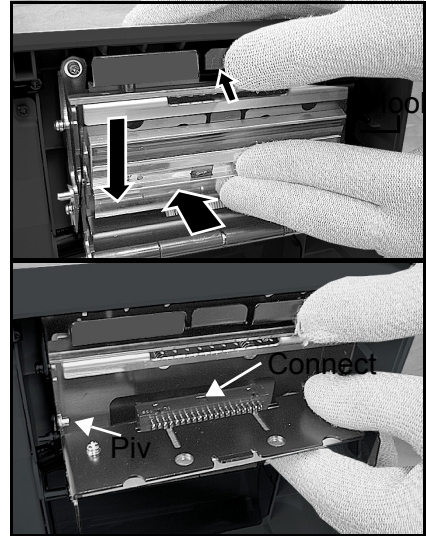

4.4 CLEANING THE SENSOR

The gap sensor is used to control the positioning of the label. It is a transmissive see-thru sensor that detects the edge of the label by looking through the backing paper which is translucent and detecting the presence of the opaque label.

So when dust, dirt or other foreign matter interferes with the light path of the sensor, erratic label positioning occurs. The sensor should thus be cleaned regularly, after every two rolls of labels.

1. Turn the printer OFF and remove the power cable.
2. Open the Top Cover.
3. Locate the sensor located next to the yellow screwdriver, near the left-hand side label guide so that it moves whenever the Label Guide are adjusted for different media widths.
4. Apply Thermal Print Head Cleaner to a cotton swab.
5. Use the cotton swab to clean any foreign matter from the exposed surface of the sensor by inserting the cotton tip in the paper slot and briskly cleaning it with a back and forth motion.

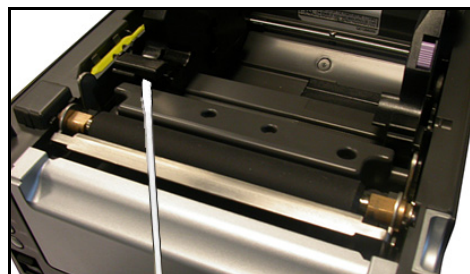

SECTION 4: CLEANING AND MAINTENANCE

This page is left blank intentionally

5

INTERFACE SPECIFICATIONS

5.1 INTERFACE TYPES

The SATO D508 / D512 printer can be ordered with any of the interfaces described in this section.

The user can specify the desired interface at the time of placing an order. Thereafter, if the user needs to change the interface, it is a simple matter of purchasing a suitable interface card from a SATO dealer.

The following are the different types of interface boards available:

- 1) **RS232C Interface Board**
- 2) **IEEE1284 Parallel Interface Board**
- 4) **USB Interface Board**
- 5) **LAN Interface Board (standard 10Base-T/100Base-T interface with RJ-45 connector)**
- 6) **Wireless LAN (802.11 b/g)**

For programmers and technical personnel to fully utilize the printer, the following information is presented in this section:

- The Receive Buffer
- IEEE1284 Parallel Interface
- RS232C Serial Interface
 - General Specifications
 - Electrical Specifications
 - Pin Assignments
 - Ready/Busy Flow Control
 - X-On/X-Off Flow Control
- Universal Serial Bus (USB) Interface
- Local Area Network (LAN) Interface
- Wireless LAN Interface (802.11b/g)

SECTION 5: INTERFACE SPECIFICATIONS

5.2 THE RECEIVE BUFFER

This printer has the ability to receive a data stream from the host in one of two ways. The receive buffer may be configured to accept one print job at a time or multiple print jobs. The single job print buffer is generally used by software programs that wish to maintain control of the job print queue so that it can move a high priority job in front of ones of lesser importance. The multiple job buffer, on the other hand prints all jobs in the order they are received by the printer, and the order of printing cannot be changed.

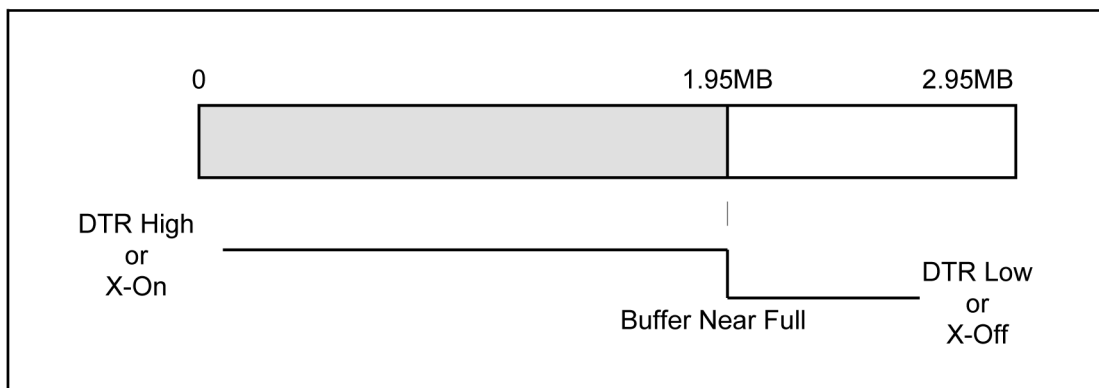

Single Job Buffer

The printer receives and prints one job at a time. Each job must not exceed 2.95MB.

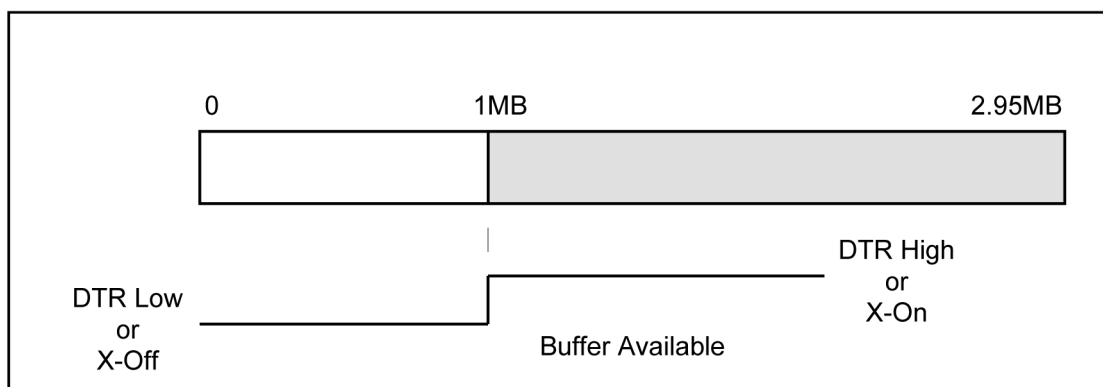

5.2 THE RECEIVE BUFFER (CONT'D)

Multi Job Buffer

The printer is able to continuously receive print jobs, compiling and printing other jobs at the same time. It acts much like a "print buffer" to maximize the performance of the host and the printer.

When you are using the RS232 Serial interface, the Multi Job Buffer uses either the Ready/Busy with DTR (pin 20) or X-On/X-Off flow control protocols. With an empty receiving buffer, the status of DTR is "high" (or an X-On status if using X-On/X-Off), meaning the printer is ready to receive data. When the receive buffer is holding 1.95MB of data (1MB from being full), DTR will go "low" (or an X-Off is sent) indicating the printer can no longer receive data. This condition is called "Buffer Near Full."

The receiving buffer will not be able to receive more data again until a "Buffer Available" condition occurs. This takes place when the receiving buffer has emptied so that only 1MB bytes of data are being held (1.95MB bytes from being full). At this time, DTR will go "high" or an X-On is sent to tell the host that it can again receive data.

All printer error conditions (i.e., label out, Time-out Error, etc) will cause the printer to go busy (DTR "low" or X-Off) until the problem is corrected and the printer is placed on-line. The printer will also be busy if taken off-line from the front panel.

SECTION 5: INTERFACE SPECIFICATIONS

5.3 IEEE1284 PARALLEL INTERFACE

The parallel interface for this printer conforms to the IEEE1284 specification. It will automatically detect the IEEE1284 signals and operate in the high speed mode. If it does not detect the IEEE1284 signals, it will operate in the standard Centronics mode, which is significantly slower. For this reason, an interface cable and host interface conforming to the IEEE1284 specification must be present to fully utilize the speed capabilities. This interface also operates bidirectionally and can report the status of the printer back to the host.

Electrical Specifications

Printer Connector	AMP 57-40360 (DDK) or equivalent
Cable Connector	AMP 57-30360 (DDK) or equivalent
Cable Length	10 ft. (3 m) or less
Signal Level	High = +2.4V to +5.0V Low = 0V to -0.4V

PIN	SIGNAL	DIRECTION	PIN	SIGNAL	DIRECTION
1	STROBE	To Printer	19	STROBE Return	Reference
2	DATA 1	To Printer	20	DATA 1 Return	Reference
3	DATA 2	To Printer	21	DATA 2 Return	Reference
4	DATA 3	To Printer	22	DATA 3 Return	Reference
5	DATA 4	To Printer	23	DATA 4 Return	Reference
6	DATA 5	To Printer	24	DATA 5 Return	Reference
7	DATA 6	To Printer	25	DATA 6 Return	Reference
8	DATA 7	To Printer	26	DATA 7 Return	Reference
9	DATA 8	To Printer	27	DATA 8 Return	Reference
10	ACK	To Host	28	ACK Return	Reference
11	BUSY	To Host	29	BUSY Return	Reference
12	PTR ERROR	To Host	30	PE Return	Reference
13	SELECT	To Host	31	INIT	From Host
14	AUTOFD (1)	To Host	32	FAULT	To Host
15	Not Used		33	Not Used	
16	Logic Gnd		34	Not Used	
17	FG	Frame Ground	35	Not Used	
18	+5V(Z=24Kohm)	To Host	36	SELECTIN ⁽¹⁾	From Host

⁽¹⁾ Signals required for IEEE1284 mode

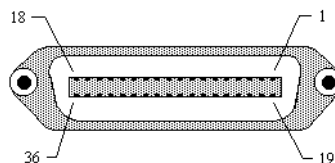

5.4 RS-232C INTERFACE

The High Speed Serial Interface is a factory installed option that must be installed in the printer at the time of order. The D508 / D512 recognizes the RS-232 interface automatically.

General Specifications

Asynchronous ASCII	Half-duplex communication
	Ready/Busy Hardware Flow Control Pin 20, DTR Control Pin 4, RTS Error Condition
	X-On/X-Off Software Flow Control Bi-Directional Communication
Data Transmission Rate	9600, 19200, 38400, 57600 bps
Character Format	1 Start Bit (fixed) 7 or 8 data bits (selectable) Odd, Even or No Parity (selectable) 1 or 2 Stop bits (selectable)

Electrical Specifications

Connector	DB-25S (Female)
Cable	DB-25P (Male), 50 ft. maximum length. For cable configuration, refer to Cable Requirements appropriate to the RS232C protocol chosen.
Signal Levels	High = +5V to +12V Low = -5V to -12V

Pin Assignments

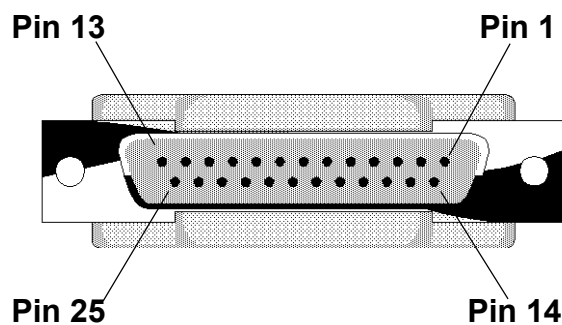

SECTION 5: INTERFACE SPECIFICATIONS

5.4.1 RS-232C INTERFACE SIGNALS

Pin	Direction	Signal Definition
1	Reference	FG (Frame Ground)
2	To Host	TD (Transmit Data) -Data from the printer to the host computer. Sends X-On/X-Off characters or status data (Bi-Directional protocols).
3	To Printer	RD (Receive Data) -Data to the printer from the host computer.
4	To Host	RTS (Request to Send) -Used with Ready/Busy flow control to indicate an error condition. RTS is high and remains high unless the print head is open (in this case, RTS would return to the high state after the print head is closed and the printer is placed back on-line) or an error condition occurs during printing (e.g. Time Out error, label out).
5	To Printer	CTS (Clear to Send) -When this line is high, the printer assumes that data is ready to be transmitted. The printer will not receive data when this line is low. If this line is not being used, it should be tied high (to pin 4).
6	To Printer	DSR (Data Set Ready) -When this line is high, the printer will be ready to receive data. This line must be high before data is transmitted. If this line is not being used, it should be tied high (to pin 20).
7	Reference	SG (Signal Ground)
20	To Host	DTR (Data Terminal Ready) -This signal applies to Ready/Busy flow control. The printer is ready to receive data when this pin is high. It goes low when the printer is off-line, either manually or due to an error condition, and while printing in the Single Job Buffer mode. It will also go low when the data in the buffer reaches the Buffer Near Full level.

Cable Requirements

DB9	DB25	HOST	INTERCONNECTION	PRINTER
1	1	FG	↔	1 FG (Frame Ground)
2	3	RD	←	2 TD (Transmit Data)
3	2	TD	→	3 RD (Receive Data)
8	5	CTS	←	4 RTS (Request to Send)
7	4	RTS	→	5 CTS (Clear to Send)
4	20	DTR	→	6 DSR (Data Set Ready)
6	6	DSR*	←	20 DTR (Data Terminal Ready)
5	7	SG	↔	7 SG (Signal Ground)

* This connection at the host side of the interface would depend upon the pin that is being used as the Ready/Busy signal by the driving software. Typically, on a PC, it would be either CTS (pin 5) or DSR (pin 6) on a DB-25 connector.

5.4.2 READY/BUSY FLOW CONTROL

Ready/Busy is the hardware flow control method for the serial interface on the printer. By raising/lowering the voltage level on Pin 20 of the RS232 port, the printer notifies the host when it is ready to receive data. Pin 4 (RTS) and pin 20 (DTR) are the important signals on the printer for this method of flow control. The host must be capable of supporting this flow control method for it to function properly.

5.4.3 X-ON/X-OFF FLOW CONTROL

X-On/X-Off flow control is used whenever hardware (Ready/Busy) flow control is not available or desirable. Instead of a voltage going high/low at pin 20, control characters representing "Printer Ready" (X-On = 11 hexadecimal) or "Printer Busy" (X-Off = 13 hexadecimal) are transmitted by the printer on pin 2 (Transmit Data) to the host. In order for this method of flow control to function correctly, the host must be capable of supporting it. X-On/X-Off operates in a manner similar to the function of pin 20 (DTR) as previously explained. When the printer is first powered on it sends an X-Off when the "Buffer Near Full" level is reached and a X-On when the data level of the buffer drops below the "Buffer Available" mark. When the printer is taken off-line manually, it transmits an X-Off indicating it cannot accept data. When it is placed back on line manually, it sends an X-On, indicating it is again available for receipt of data. If an error occurs during printing (paper out, Time Out), the printer sends an X-Off as soon as an error condition is detected. When the error is cleared and the printer is placed back on-line, it transmits an X-On indicating it is again ready to accept data.

Upon power up if no error conditions are present, the printer will continually send X-On characters at five millisecond intervals until it receives a transmission from the host.

5.5 UNIVERSAL SERIAL BUS INTERFACE

The Universal Serial Bus (USB) interface is a factory installed option that must be specified at the time of order. It requires a driver (shipped with each printer that has the interface installed) that must be loaded on your PC and the PC must be configured to support USB peripherals using Microsoft Windows. Details for loading the USB driver are contained in the USB Interface Manual that is shipped with each printer with a USB Optional interface installed. Up to 127 devices may be connected to a USB port.

5.6 LOCAL AREA NETWORK INTERFACE

A Local Area Network (LAN) interface is a factory installed interface option that must be specified at the time of order. It requires a driver (shipped with each printer that has the interface installed) that must be loaded on your PC and the PC must be configured to support the TCP/IP network protocol using a 10BaseT LAN connection. Details for loading the LAN driver are contained in the LAN Interface Manual that is shipped with each printer with a LAN Optional interface installed.

SECTION 5: INTERFACE SPECIFICATIONS

5.7 WIRELESS LAN INTERFACE (802.11 B/G)

The wireless print server provides easy printer interface with 802.11G Wi-Fi compliant networks free of wired connections. Each printer is shipped with an integrated driver and interface installed. The driver must be loaded onto the host computer and configured to run one of the supported protocols.

SPECIFICATIONS	
Variable Data Rates	54, 11, 5.5, 2 and 1 Mbps
Frequency Band	2.4 GHz ISM Band
Wired Equivalent Privacy	128 bit, 64 bit (compatible with 40bit), WPA, none
Sensitivity	(typ, AAWGN, 8E-2 PER): -91dBm at 1Mbps, -88dBm at 2 Mmps, -87dBm at 5.5Mbps, 84dBm at 11Mbps.
Range	100m indoors, 300m outdoors
Protocols	TCP/IP, IPX/SPX, Direct Mode IPX/IP, DLC/LLC, NetBEUI, NetBIOS/IP
Protocol	Status3 return Protocol for Driver (cyclic response mode) Protocol for Driver (ENQ response mode) Status5 return
IP Address	0.0.0.0 to 255.255.255.255
Subnet Mask	0.0.0.0 to 255.255.255.255
Gateway Address	0.0.0.0 to 255.255.255.255
Communication Mode	802.11 Ad hoc, Ad hoc, Infrastructure
SSID	Optional alphanumeric character string (up to 32 characters)
Channels	01 to 11

DIP SWITCH SETTINGS	
<p>The DIP switches serve to initialize the configuration saved on the Wireless-LAN board, print the configuration, and make a self-diagnosis. To communicate with the host, set the communication mode by through switches 5 and 6, then set the remaining switches to the OFF position.</p> <p>Print of configuration and self-diagnosis are operable only on the screen after turning on the printer. Ensure all switches are in the OFF position when operating the printer.</p>	
SWITCH	SETTING
1	Reserved for test use only (setup prohibited).
2	LAN board EEPROM initialization (initialize configuration).
3	Print configuration details on a label (diagnostic & configuration).
4	Print a self-diagnosis of the board onto a label (wireless mode).
<p>NOTE: The communication mode may be set within the printer's Interface Mode. Go to [Communication] of the Interface Mode to enable setup by either the DIP switches or through the Interface Mode.</p>	

LED INDICATOR STATUS			
INDICA-TOR 1	INDICA-TOR 2	INDICA-TOR 3	DESCRIPTION
ON	OFF	OFF	Weak Signal (1-50%)
ON	ON	OFF	Moderate Signal (50-75%)
ON	ON	ON	Strong Signal (75-100%)
OFF	OFF	ON	802.11 Ad hoc
OFF	ON	OFF	Ad hoc

SOFTWARE SPECIFICATIONS	
Corresponding Protocol	TCP/IP
Network Layer	ARP, RARP, IP, ICMP
Session Layer	TCP, UDP
Application Layer	LPD, FTP, TELNET, BOOTP, DHCP
NOTE: Print data can be sent by LPR and FTP of TCP/IP and dedicated socket protocol. Printer status is obtainable by dedicated socket protocol.	
NOTE: In the TCP/IP protocol enviroment, LPD and FTP are provided for printing; TELNET for variable setup; ARP, RARP, and BOOTP/DHCP for address setup.	
LPD protocol complies with RFC1179 and handles the list of logical printer name as queue name such as lp, sjis, euc. In addition, a banner page can be printed by a proper setup. When sending the job by LPR, the transmission order of data file/control file within the job will not affect print operation. In addition, if the banner page is specified, it will be added to each data file. Job deletion by LPR is not available.	
FTP protocol complies with RFC959 and handles the list of logical printer name as a transfer directory. File transfer to this directory executes print operation. It is possible to specify ASCII(A), Binary(I) and TENEX(L8) as transfer mode - although the mode difference is dependent on the client. A banner page may be printed with a proper setup.	
TELNET Complies with RFC854. This operation consists of interactive menu form and enables change and reference of internal setup, and to display status. To change the setup, enter "root" user and password at the time of login. Default of root pasword is set as null (linefeed only).	

6

TROUBLESHOOTING

This section has been devised to help you if you are unable to produce output on the SATO D508 / D512 printer. Use this section to make sure the basics have been checked before deciding you are unable to proceed any further. The section is divided into three parts:

- Initial Checklist
- Checklist for the Parallel Interface
- Checklist for the RS232C Serial Interface

6.1 INITIAL CHECKLIST

1. Is the printer powered up and ON LINE?
2. Is the ERROR light on the front panel OFF? If this light is ON, it may mean the print head assembly is open or another error condition is present.
3. Is the Print Head Assembly properly latched? Are the other sections secured and aligned properly?

6.2 CHECKING THE IEEE1284 PARALLEL INTERFACE

1. Is the IEEE1284 printer cable connected securely to your parallel port (DB-25S Female) on the PC and to the parallel IEEE connector on the printer?
(Warning: when disconnecting or connecting interface cables, always make sure the printer is OFF. Otherwise, the printer's interface may suffer damage that is not covered by the warranty.)
2. Does the interface cable in use meet IEEE1284 specifications?
3. Is there more than one parallel interface port on your PC (LPT1, LPT2, etc.)? If so, make sure you are sending data out the correct port.
4. When you send the print job to the printer, and it does not respond, do you get an error message on your PC that says "Device Fault" or something similar?

Observations

6.2 USING THE IEEE1284 (PARALLEL) INTERFACE (CONT'D)

Observations

This may mean that the computer doesn't know the printer is there. Verify that:

- a. Both ends of the cable are securely inserted into their respective connectors
- b. The printer is ON LINE
- c. The cable is not defective. There are other things that can cause this error message on your computer, but at this stage, a defective cable may be one of the reasons

- 6. When you send the print job to the printer and it does not respond, and there is no error message on the PC:
 - A. Check your data stream to make sure it complies with standard SATO commands.
 - B. Verify that you've included all required parameters in the data stream.
 - C. Verify the following:
 - You have not typed a "0" (zero) for an "O" (letter) or vice-versa.
 - You have not missed any SPBL commands/headers where they're needed.
 - Make sure all printer command codes are capital letters.

- 7. If you've checked all of the above and the printer still isn't printing, you may want to try a Receive Buffer DATA Dump to determine what (if anything) the printer is receiving from your computer. To print DATA Dumps see page 3-11, Configuration and Operation.

The parallel port is now listening for incoming data. Send your print job. The printer will now print (only once) a DATA Dump of everything it received from the host computer. Each 2-digit hexadecimal character represents a character the printer received. It may be tedious, but now you can analyze and troubleshoot the data stream.

- 8. While checking the DATA Dump printout, look out for the sequence 0D 0A, which is a combination of Carriage Return and Line Feed characters. The command string should be continuous, and you should not see CR or LF characters between the SBPL commands.

6.2 CHECKING USING THE PARALLEL INTERFACE (CONT'D)

If you are using BASIC, it may be adding these characters automatically as the line wraps. Adding a "width" statement to your program can help to suppress these extra 0D 0A characters by expanding the line length up to 255 characters.

If you are not programming in BASIC, check to see if you have an equivalent statement in the language you're using, to suppress extra carriage returns and line feeds from your data being sent out to the printer. The data stream should be one complete line going to the printer.

Observations

6.3 CHECKING THE RS232C (SERIAL) INTERFACE

Observations

1. Is the RS232C Serial cable connected securely to your serial port on the PC (DB- 25S Male) and to the RS232C connector on the printer? (**Warning:** *when disconnecting or connecting interface cables, always make sure the printer is **OFF**. Otherwise, the printer's interface may suffer damage that is not covered by the warranty.*)
2. Is the cable defective? At the very least, you should be using a "Null Modem Cable," which crosses pins in a specific manner. This should enable your printer to print. But we recommend that you eventually use a cable built to specifications as described in **Section 5: Interface Specifications**
3. Check for obvious errors in the data stream, if you are familiar with the software commands.
4. If after sending your job to the printer, it only "beeps" indicating a "framing error" message, you may have a configuration problem. There may be some inconsistencies with the Baud Rate, Parity, Data Bits, or Stop Bits in relation to your host computer. If you are confused as to what the printer's current RS232 settings are, you may choose the SATO defaults (all DIP switches in the OFF position) to achieve 9600 baud, no parity, 8 data bits, and 1 stop bit.
5. If you still are unable to get printer output, try the DATA Dump as described in Step 5 under the Parallel IEEE1284 Interface troubleshooting. In this case, the printer monitors its RS232C interface for incoming data.
6. From the DATA Dump, if you are seeing extra 0D 0A (CR and LF) characters, and are using BASIC, refer to the beginning of the Command Code section. It provides hints for writing a SATO program in BASIC.

6.3 ERROR SIGNALS

The 7-segment LED display, Front Panel LED Indicators and Buzzer combine to provide a visual/aural indication of the type of error encountered.

For information on error messages and icons, proceed to the next section.

Display	LED INDICATORS		BUZZER	ERROR CONDITION	CORRECTIVE ACTION
	LINE	ERROR			
0		ON	1 Beep	Flash Memory error	Consult your SATO dealer
1				Not Assigned	
2		ON	1 Beep	Machine Error	Consult your SATO dealer
3		ON	1 Beep	EEPROM Error	Replace EEPROM
4		ON	1 Beep	Electrical Head error	Replace Print Head or consult your SATO dealer
5		Blink	3 Beeps	Head Not Latched	Latch Print Head securely and make sure the Top Cover is closed properly
6		Blink	3 Beeps	Out of Paper	1) Replenish paper supply 2) Route paper through sensor correctly
7		Blink	3 Beeps	Sensor error	1) Adjust sensor level
8		Blink	3 Beeps	Cutter error	Connect cutter (optional item) properly or consult your SATO dealer
8.	ON	ON		Program Error	Resend data to the printer
A	ON		1 Beep	Receive Buffer Overflow	1) Restart the printer and retry 2) Modify host SW 3) Select correct communication protocol settings
b	ON		1 Beep	Parity error (Serial I/F only)	Correct the Parity Settings or consult your SATO dealer
c	ON		1 Beep	Framing Error (Serial I/F only)	Check and correct the data bit setting and retry
d	ON		1 Beep	Overrun Error (Serial I/F only)	Check and correct the flow control settings and retry
E	ON		1 Beep	LAN Time Out Error	Check the Interface Card and all associated connections to/from it. Replace if necessary
F			3 Beeps	Font/graphic Data Error (Serial I/F only)	Recheck and correct the data stream and retry

SECTION 6: TROUBLESHOOTING

6.3 CHECKING THE 802.11G WIRELESS INTERFACE

1. Is the antenna properly and completely installed?
2. Is the interface properly seated in the printer?
3. Are the green connection lights on the back of the interface board illuminated?
4. If it is not obtaining an IP address, check the SSID or encryption and ensure those were properly entered.
5. In order to determine the IP address obtained through the DHCP wireless device, power off the printer, place switch 3 in the upward position on the wireless card, and reinsert it into the printer, and power the printer on. Wait approximately 30 seconds for a print out of configurations.

7

SATO CONTACTS

SATO GROUP OF COMPANIES

Asia Pacific & Oceania Region

SATO ASIA PACIFIC PTE. LTD.

438A Alexandra Road #05-01/04,
Alexandra Technopark, Singapore 119967
Tel: +65-6271-5300
Fax: +65-6273-6011
Email: technical@satoasiapacific.com
www.satoasiapacific.com

SATO AUTO-ID MALAYSIA SDN. BHD.

No.25, Jalan Pemberita U1/49,
Temasya Industrial Park, Section U1,
40150 Shah Alam, Selangor Darul Ehsan,
Malaysia
Tel: +60-3-7620-8901
Fax: +60-3-5569-4977
Email: service@satosms.com.my
www.satoasiapacific.com

SATO AUTO-ID (THAILAND) CO., LTD.

292/1 Moo 1 Theparak Road,
Tumbol Theparak, Amphur Muang,
Samutprakarn 10270, Thailand
Tel: +66-2-736-4460
Fax: +66-2-736-4461
Email: technical@satothailand.com
www.satothailand.co.th

SATO SHANGHAI CO., LTD.

307 Haining Road, ACE Bldg,
10th Floor, Hongkou Area, Shanghai,
China 200080
Tel: +86-21-6306-8899
Fax: +86-21-6309-1318
Email: tech@satochina.com
www.satochina.com

SATO ASIA PACIFIC PTE. LTD.

Korea Representative Office
6F, Korea Housing Center,
Yeouido-dong 45-11, Yeongdeungpo-gu,
Seoul, Korea 150-736
Tel: +82-2-761-5072
Fax: +82-2-761-5073
Email: technical@satoasiapacific.com
www.satoasiapacific.com

SATO ASIA PACIFIC PTE. LTD.

India Representative Office
Regus Level 2, Connaugh Place,
Bund Garden Road, Pune. 411001, India
Tel: +91-20-4014-7747
Fax: +91-20-4014-7576
Email: technical@satoasiapacific.com
www.satoasiapacific.com

SATO AUSTRALIA PTY LTD.

1/1 Nursery Avenue, Clayton Business
Park, Clayton, VIC 3168 Australia
Tel: +61-3-8814-5330
Fax: +61-3-8814-5335
Email: enquiries@satoaustralia.com
www.satoaustralia.com

SATO NEW ZEALAND LTD.

30 Apollo Drive, Mairangi Bay
Auckland, New Zealand
Tel: +64 9-477-2222
Fax: +64-9-477-2228
Email:
global.warranty@satonewzealand.com
www.satonewzealand.com

European Region

SATO LABELLING SOLUTIONS EUROPE GmbH (BELGIUM)

Leuvensesteenweg 369,
1932 Sint-Stevens-Woluwe, Belgium
Tel: +32-2-788-80-00
Fax: +32-2-788-80-80
Email: info@nl.satoeurope.com
www.satoeurope.com

SATO LABELLING SOLUTIONS EUROPE GmbH (GERMANY)

Ersheimer Straße 71,
69434 Hirschhorn, Germany
Tel: +49-6272-9201-160
Fax: +49-6272-9201-347
Email: service@de.satoeurope.com
www.satoeurope.com

SATO LABELLING SOLUTIONS EUROPE GmbH (NORWAY)

Hovfaret 4 0275 Oslo, Norway
Tel.: +47-225-106-70
Fax: +47-225-106-71
Email: kundeservice@satonorge.com
www.satoeurope.com

SATO LABELLING SOLUTIONS EUROPE GmbH (NETHERLANDS)

Techniekweg 1b, 3481 MK Harmelen,
Netherlands
Tel.: +31-348-444437
Fax: +31-348-446403
Email: info@nl.satoeurope.com
www.satoeurope.com

SATO LABELLING SOLUTIONS EUROPE GmbH (ITALY)

Viale Europa 39/1,
20090 Cusago, Milano, Italy
Tel.: +39-2-903-944-64
Fax: +39-2-903-940-35
Email: info@it.satoeurope.com
www.satoeurope.com

SATO LABELLING SOLUTIONS EUROPE GmbH (SWITZERLAND)

Allmendstraße 19,
8320 Fehraltorf, Switzerland
Tel: +41-44-954-84-00
Fax: +41-44-954-84-09
Email: info@ch.satoeurope.com
www.satoeurope.com

SATO LABELLING SOLUTIONS EUROPE GmbH (AUSTRIA)

Niederlassing Austria
Jochen-Rindt-Straße 13
1230 Wien, Austria
Tel: +43-2762-52690
Fax: +43-2762-52018
Email: info@at.satoeurope.com
www.satoeurope.com

SATO LABELLING SOLUTIONS EUROPE GmbH (DENMARK)

Naverland 29A DK-2600
Glostrup, Denmark
Tel.: +45-43204700
Fax: +45-43204709
Email: info@dk.satoeurope.com
www.satoeurope.com

SATO POLSKA SP. Z O.O.

ul. Wrocławska 123, Radwanice,
55-015 Św. Katarzyna, Poland
Tel: +48-71-381-03-60
Fax: +48-71-381-03-68
Email: info@sato.pl
www.sato.pl

SATO IBERIA S.A.

Dels Corralis Nous, 35-39
Pol. Can Roqueta, 08202 - Sabadell
Barcelona, Spain
Tel: +34-902-333-341
Fax: +34-902-333-349
Email: info@es.satoeurope.com
www.satoeurope.com

SATO FRANCE S.A.S.

Parc d'Activités, Rue Jacques Messenger,
59 175 Templemars, France
Tel: +33-3-20-62-96-40
Fax: +33-3-20-62-96-55
www.satoeurope.com

SATO UK LTD.

Valley Road, Harwich,
Essex CO12 4RR, United Kingdom
Tel: +44-1255-240000
Fax: +44-1255-240111
Email: enquiries@satouk.com
www.satouk.com

American Region

SATO AMERICA, INC.

10350-A Nations Ford Road, Charlotte,
NC 28273, U.S.A.
Tel: +1-704-644-1650
Fax: +1-704-644-1662
www.satoamerica.com

SATO LABELING SOLUTIONS AMERICA, INC.

1140 Windham Parkway, Romeoville,
Illinois 60446, U.S.A.
Tel: +1-800-645-3290
Fax: +1-630-771-4210
www.satolabeling.com

- Extensive contact information of worldwide SATO operations can be found on the Internet at www.satoworldwide.com